

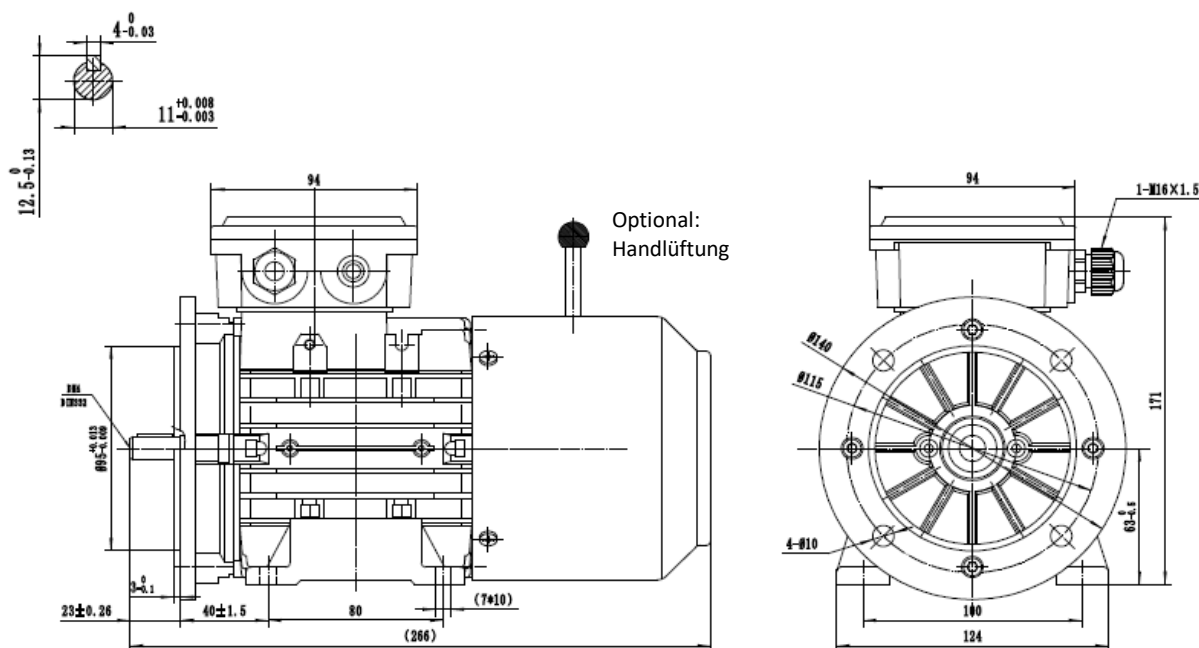

# Drehstrombremsmotor / Three-Phase-Brakemotor

## IE3 - 0,25 kW - 2 polig / 2 pole B35



Typ / type **SEV-BM3 632-2**

Gehäusematerial / frame material		Aluminum	Nenn Drehmoment / rated torque	0,84
Ausführung / execution		Dreiphasen/ three phase	Anzugs- zu Nennmoment / start- to rated torque	2,5
Baugröße / frame size		63	Kipp- zu Nennmoment / brakedown- to rated torque	2,7
Leistung / power @50Hz	kW	0,25	min. Dreh- zu Nennmoment / min- to rated torque	2
Nennstrom / rated current @230V	Δ	1,15	Anzugs- zu Nennstrom / starting- to rated current	5,2
Nennstrom / rated current @400V	Y	0,66	Lager / bearing (DE)	6201-2RZ
Drehzahl / speed @50Hz	(r/min)	2840	Lager / bearing (NDE)	6201-2RZ
Wirkungsgrad / efficiency	<b>IE3</b>		Wellendichtung / shaft seal (DE/NDE)	12x22x5
	Eff. 100%	69,70	Hauptkabelverschraubung / main cable glands	1-M16*1.5
	Eff. 75%	68,40	Isolationsklasse / insulation class	F
	Eff. 50%	62,50	Schutzart / protection degree	IP 55
Leistungsfaktor / power factor cosφ	100% load	0,78	Thermischer Schutz / thermal protection	3*PTC
60Hz 265/460V	Power(kW)	0,29	Drehrichtung / rotation direction	rechts-links / clockwise-counterclockwise
60Hz 276/480V	Power(kW)	0,30	Einschaltdauer / service duty	S1
Drehzahl / speed @60Hz	(r/min)	3410	Wuchtung / balance	Halbkeilwuchtung / half-key balanced
Ausführung Bremse / execution brake		BLC457-06	Kühlungsart / cooling	IC 411
Bremsmoment / braking torque (@ 100 Upm / rpm)		4	Lautstärke / noise dB(A)	61
Normen / regulations		IEC / DIN / ISO / VDE / EN	Nettogewicht / net weight(kg)	5,39
Standard / standard		IEC 60034	Massenträgheitsmoment / moment of inertia (kg*m <sup>2</sup> )	0,000255000
Umgebungstemperatur / ambient Temp.		-20°C ~ +40°C	Aufstellungshöhe / altitude (max.)	1000m über Meeresspiegel / above sea level